

EVO4
User manual



Index

Chapter 1 – EVO4 kit and part numbers	2
1.1 – EVO4 kits and spare parts (part numbers)	3
1.2 – Optional part numbers	3
Chapter 2 – EVO4 functions.....	4
2.1 – Speed channels	5
2.2 – Lap channel	5
2.3 – ECU connection.....	5
2.4 – EVO4 expansions	6
2.5 – EVO4 USB communication	6
2.6 – RPM channel.....	6
2.6.1 – Sampling the RPM via CAN bus/RS232.....	6
2.6.2 – Sampling RPM from the ECU through a square wave signal.....	6
2.6.3 – Sampling the RPM from the coil: RPM low voltage input	7
2.6.4 – How to configure the output signal on pin 5 of RPM connector.....	10
2.7 – Analog channels.....	11
2.8 – Led status signal.....	12
Chapter 3 – Installation and powering	13
3.1 – How to power EVO4	13
3.1.1 – GND	13
3.2 – The three-axial accelerometer.	14
3.3 – Installing and powering the IR transmitter and receiver	16
3.3.1 – The infrared (IR) transmitter	16
3.3.2 – The infrared (IR) receiver.....	17
3.4 – How to install EVO4 displays.....	18
3.5 – GPS lap timer through the displays	18
3.5.1 – GPS lap timer configuration.....	18
3.5.2 – How to configure GPS lap timer on the display.	18
Chapter 4 – EVO4 memory.....	19
Chapter 5 – EVO4: software, driver, configuration, transmission, data download, online function, maintenance	20
Appendix – Technical drawings	21

Chapter 1 – EVO4 kit and part numbers

EVO4 belongs to the last generation of AIM data acquisition systems for car/bike installation: a powerful, compact, reliable and expandable logger with **integrated GPS**.

EVO4 monitors RPM, speed, engaged gear, lap (split) times standard and custom sensors. **EVO4** is a modular datalogger and communicates via CAN bus with: **Channel expansion**, **TC Hub** – AIM thermocouples multiplier – **LCU-ONE** Lambda controller and **MemoryKey** – the simple and quick way to save data and transfer to your Pc



With reference to the image here above **EVO4** kit includes:

- EVO4 (1);
- GPS antenna (2);
- Infrared transmitter with power cable (3);
- Infrared receiver (4);
- RPM cable (5);
- ECU interface cable; (6)
- USB data download cable; (7)
- CD **Race Studio 2** and this tutorial (8).

Each kit is also available with the Formula steering wheel (9) to be plugged into the expansions connector labelled “Exp”.

Optional:

- Displays: **Mycron3 Dash**, **TG Dash** and **Formula Steering wheel**;
- Expansions;
- RPM adapter (only to sample an inductive RPM signal from the spark plug);
- External **Memory Key** for data backup;

1.1 – EVO4 kits and spare parts (part numbers)

EVO4 kits are distinguished by the length of the GPS antenna cable and of the receiver power cable.

- | | |
|---|------------------|
| • Kit EVO4 with 4 m antenna and 90 cm receiver cable | X60E44090 |
| • Kit EVO4 with 4 m antenna and 140 cm receiver cable | X60E44140 |
| • Kit EVO4 with 4 m antenna and 300 cm receiver cable | X60E44300 |
| • Kit EVO4 with 1,3 m antenna and 90 cm receiver cable | X60E41309 |
| • Kit EVO4 with 1,3 m antenna and 140 cm receiver cable | X60E41314 |
| • Kit EVO4 with 1,3 m antenna and 300 cm receiver cable | X60E41330 |

Please note: all EVO4 kits are available also with Formula steering wheel included. These kits part numbers have the letters VF at the end of the code.

Spare parts part number:

- | | |
|--------------------|------------------|
| • RPM cable | V02563020 |
| • Serial/CAN cable | V02563010 |
| • USB cable | V02563030 |

1.2 – Optional part numbers

Two speeds split cable:	V02549030
K/L Line cable for ECU interface	V02563050
CAN with OBDII connection cable for ECU interface	V02563040
MyChron3 Dash:	X30VDAM01
TG Dash:	X45VDAM01
Volante Formula:	X07VOLFORM
MemoryKey:	X50MEPC00
Data hub (with 150 cm cable):	X08HUB150
Channel expansion:	X08CHEXUC
TC Hub:	X08UTCCTC
LCU-ONE CAN Lambda Controller:	X08LCU03K0

Chapter 2 – EVO4 functions

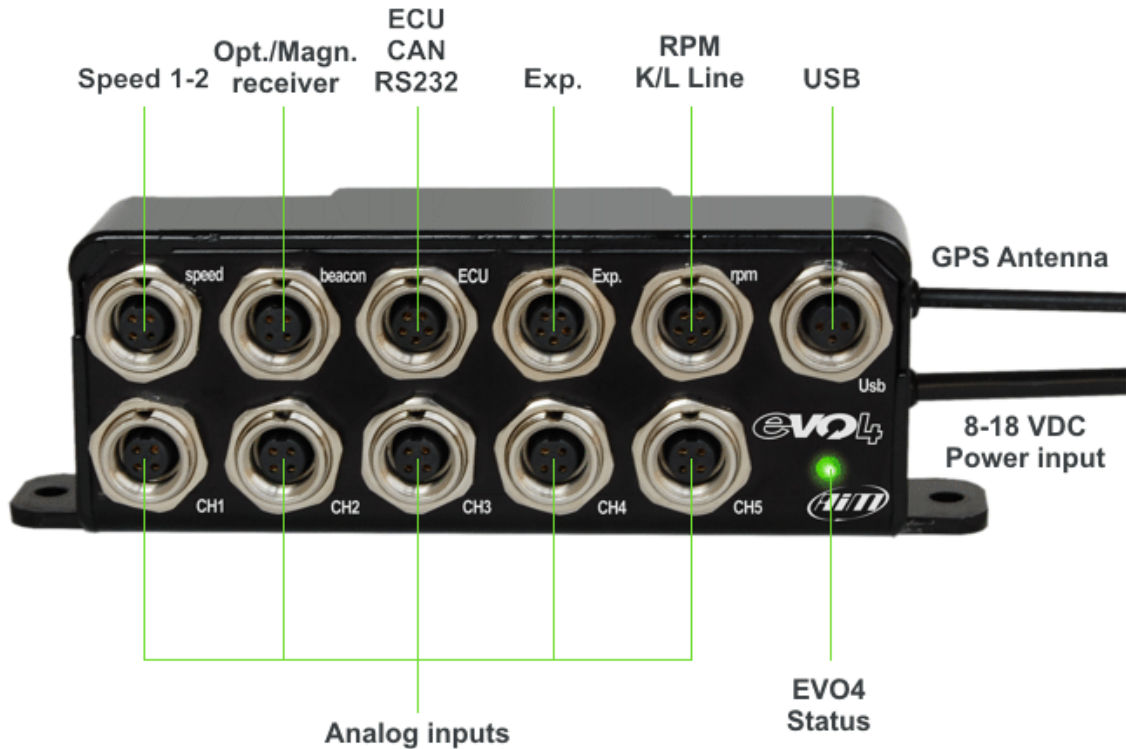

EVO4 is a powerful and versatile instrument, that shows functions usually optional and that can be connected to numerous expansions.

Main features:

- integrated GPS Module;
- 5 configurable analog channels;
- 2 speed inputs;
- 1 RPM channel;
- 1 internal tri-axial accelerometer;
- Lap time (magnetic/optic/GPS);
- ECU Interface;
- CAN protocol for external expansion modules;
- 16 Mb Memory;
- USB port for data download;
- 5 KHz sampling frequency;
- 8/18 V external power.

As shown here above **EVO4** front has 11 connectors and a led with specific functions.

2.1 – Speed channels

To sample the two speed channels a split optional cable is needed. Its part number is: **V02549030**. Plug it into the connector labelled “Speed”.

2.2 – Lap channel

To sample lap time just plug the receiver included in the kit into the connector labelled “Beacon”.

2.3 – ECU connection

EVO4 can sample data coming from the vehicle ECU using CAN/RS232 protocols or the K/L Line: use the ECU interface cable for CAN/RS232 protocol and the RPM cable for the K/L line. Both cables are included in the kit. Refer to the appendix technical draws for further information on these cables.

Always refer to the ECU user manual for any further information concerning pins and cables connection.

To be sure that the vehicle ECU is supported by **EVO4** and for updated information on ECU – AIM loggers connection refer to the related documentation downloadable from AIM corporate website, download area ECU section.

ECU connections depends on the communication protocol used by the ECU.

With CAN/RS232 protocol use ECU interface cable and the 5 pins male Binder connector labelled “ECU” on **EVO4** front panel. Please note: a CAN cable with OBDII connection (optional) is available. The connection is:

- CAN +: pin 3 white cable labelled CAN +;
- CAN -: pin 5 blue cable labelled CAN - ;
- RS232RX pin 4 white cable labelled RS232RX;
- RS232TX pin 1 blue cable labelled RS232TX;

With the K/L line use RPM cable and the 5 pins male Binder connector labelled “RPM” on **EVO4** front panel. The connection is:

- K/L line pin 4 yellow cable labelled K line.

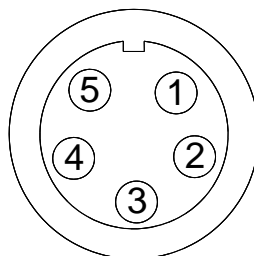

5 pins Binder 712 male connector pinout – solder termination view.

In case non-standard CAN or RS232 lines need to be converted, contact our technical support.

2.4 – EVO4 expansions

Connector labelled “Exp.” links **EVO4** to numerous expansions increasing its potentialities.

As said all kits are also available with the **Formula Steering Wheel** that plugs exactly in this connector. To connect more expansions (for example a **Formula Steering wheel** and an **LCU-One Lambda control**) a **Data Hub** is needed so to increase the available connections for expansions modules.

Warning: connect any expansion to EVO4 OFF.

2.5 – EVO4 USB communication

Connector labelled “USB” links **EVO4** to a PC to configure it with Race Studio 2 software and download stored data. USB cable comes with the kit.

2.6 – RPM channel

EVO4 can sample RPM signal in different ways:

- from the ECU via CAN bus or RS232;
- from the ECU through a square wave signal (from 8 to 50V);
- from the coil: RPM low voltage (from 150 to 400V) input;
- from the spark plug converting the signal sampled from the spark plug into a square wave signal. In this case it is necessary to use an RPM adapter (optional).

2.6.1 – Sampling the RPM via CAN bus/RS232

To sample RPM from the ECU via CAN/RS232 use the connector labelled “ECU”.

2.6.2 – Sampling RPM from the ECU through a square wave signal

To sample RPM from the ECU through a square wave signal (from 4 to 50V), connect the blue cable labelled “RPM 4-50V” of the 5 pins male Binder connector to RPM output of the ECU (see appendix technical draw – code 04.563.02).

It can occur that the RPM signal coming out from the ECU is not correctly sampled by **EVO4** because is very unstable.

In this case, to obtain a stable square wave signal an (optional) RPM adapter is needed. The images below show – on the left – a not square wave RPM signal coming from the ECU and – on the right – a filtered one.



To connect the RPM adapter follow this procedure.

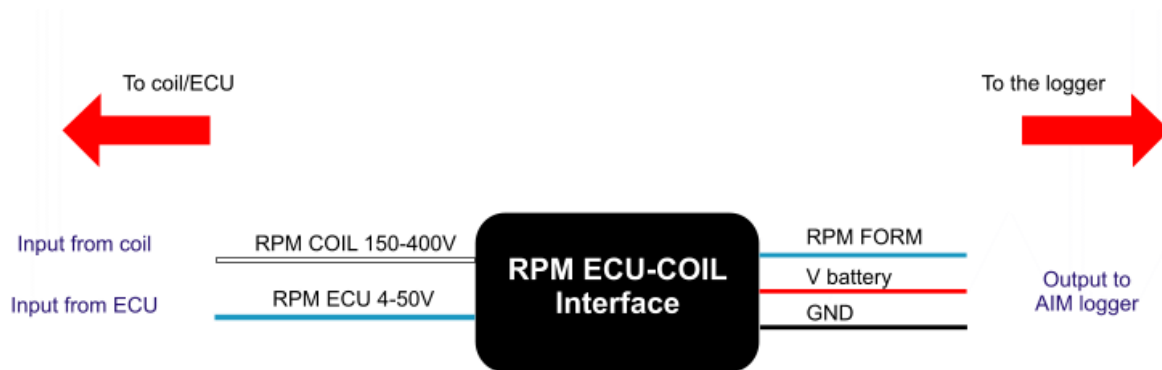

- Connect cable labelled RPM-ECU 4-50 V to ECU RPM output.
- Connect the blue cable of the adapter, “labelled RPM form” to “RPM form 8-50 Volt square wave” input of **EVO4**.
- Connect the red cable of the interface labelled “V battery” to the battery positive pole. Connect the red cable downstream the vehicle master switch.
- Connect the interface black cable, labelled GND to the logger GND pin (refer to the appendix technical draw code 04.563.02 for further information).

2.6.3 – Sampling the RPM from the coil: RPM low voltage input

To sample RPM signal from the coil on a low voltage RPM input (from 150 to 400V), connect 5 pins Binder 712 male connector pin to ECU RPM output using the white cable labelled RPM 150-450V (see appendix technical draw code 04.563.02).

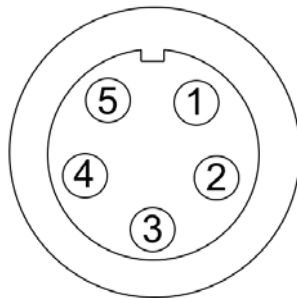

It can occur that RPM signal produced by the coil is not correctly sampled by **EVO4** because the signal is very unstable.

The image below shows a connection scheme example of the ignition key. Here below is highlighted the out coming cable – labelled gray tach – that can be sampled directly from **EVO4** through the 4-50 Volt (see appendix technical draw code 04.563.02 – pin 3).

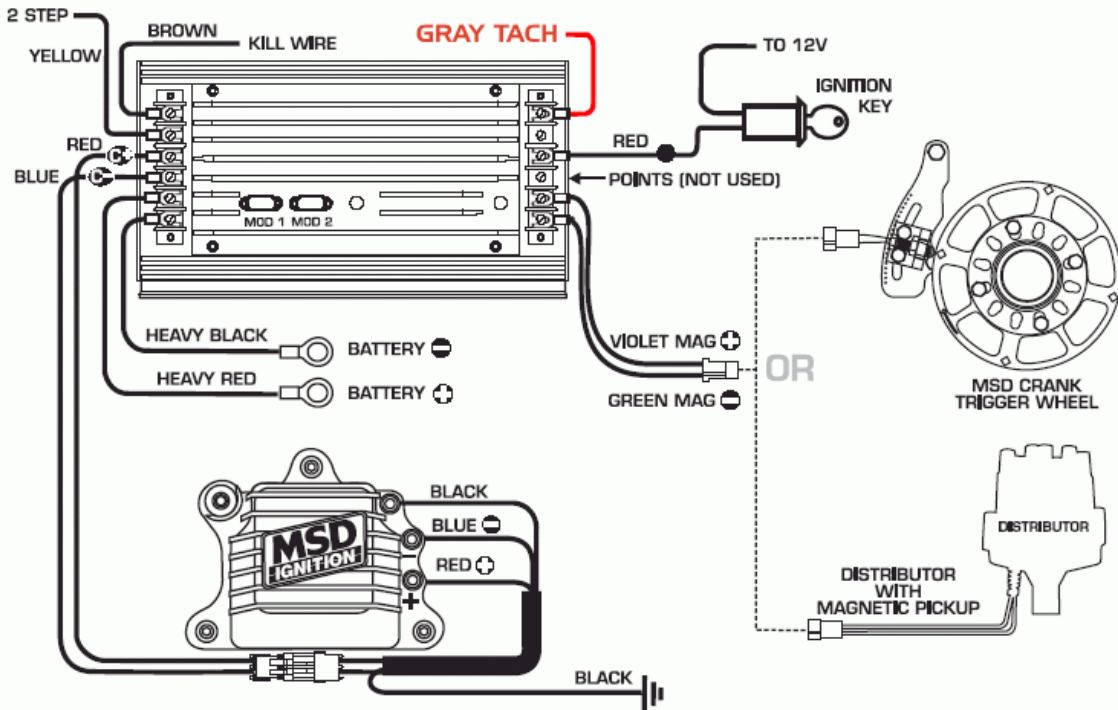

In case an ignition output is not available, it is necessary to use a signal coming from the coil after having filtered it.

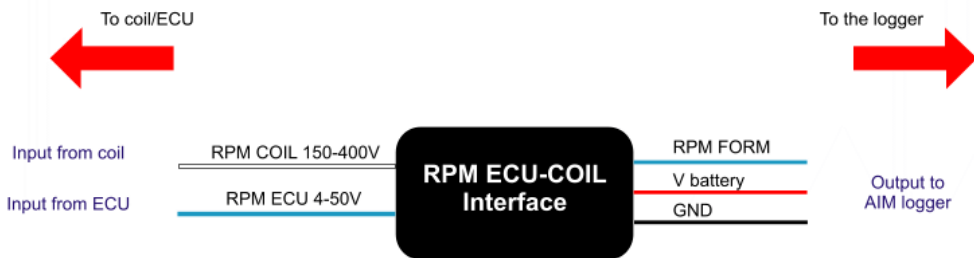

Here below an RPM signal coming from the coil is shown: not filtered on the left and filtered on the right.

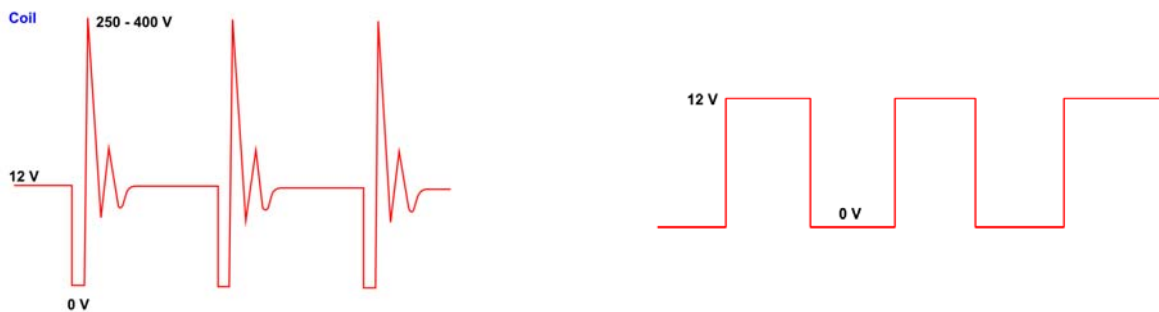

To filter the signal use an “RPM Coil-ECU” adapter (optional). It is a double-purpose filter that allows to sample RPM from the coil and squares the signal wave form.

The coil to sample the signal from, shown here below, is a black cylinder with three cables (labelled 1,2 and 3).

Cable labelled 1 is the coil low tension input.

Cable labelled 2 is connected to the coil.

Cable labelled 3 is connected to the battery positive pole (+12V).

Moreover the coil is generally grounded with the chassis as shown by the scheme below on the right.

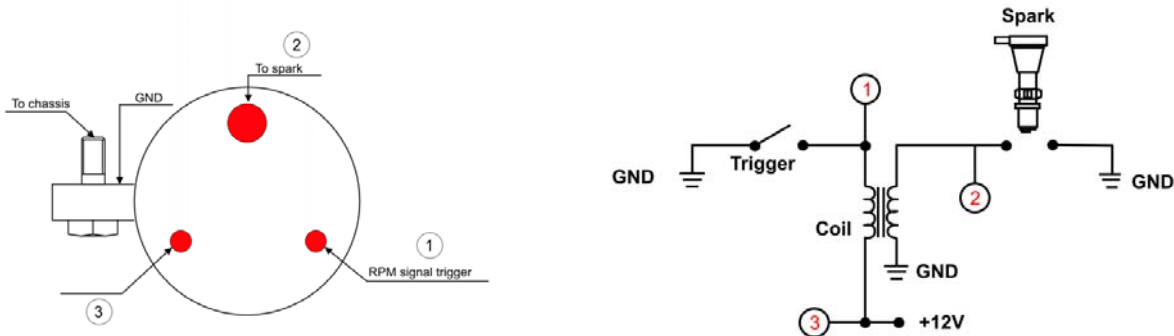

The scheme below shows the voltage in the points labelled 1,2 and 3 in the images here above.

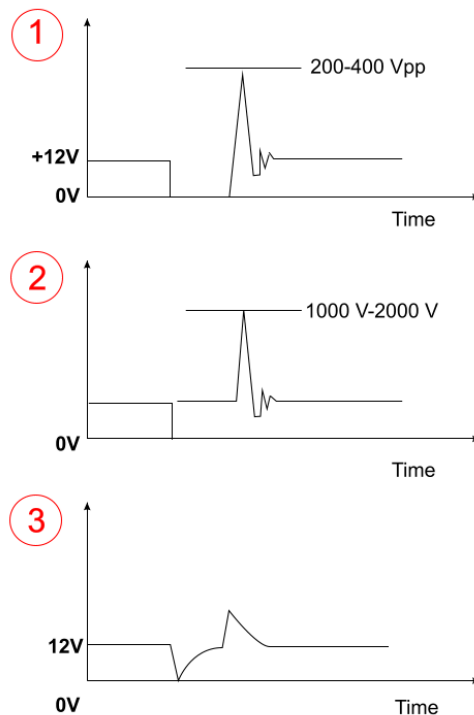

It is reminded that the adapter white cable, labelled "RPM-Coil 150-400 V" is to be connected to the RPM trigger wiring indicated by digit 1 in the above schemes.

2.6.4 – How to configure the output signal on pin 5 of RPM connector

The output signal on pin 5 of RPM connector is to be configured through Race Studio 2 software. Run the software and follow this path: press “AIM system Manager” >> choose EVO4>>select the configuration of the EVO4 connected or create a new one>> activate “System configuration layer”: the panel below is at the bottom. Refer to Race Studio Configuration user manual – EVO4 chapter – for further information about this logger configuration.

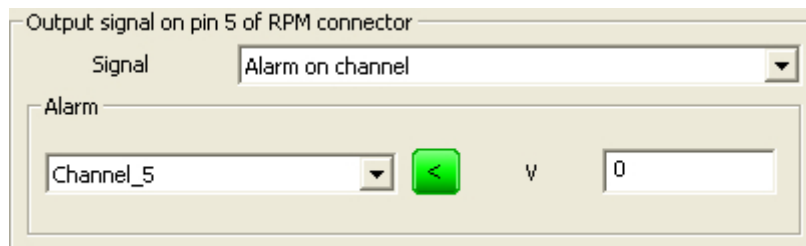

This function allows **EVO4** to send a signal to an external device, typically a display or an ECU. This output signal is connected to pin 5 of RPM connector of **EVO4** and has the following characteristics:

- **Voltage:** Depends on the external pull-up voltage
- **Output duration:** about 0,8 seconds [for Lap (-) and Lap (+)only]
- **Type:** can be type “Lap” or type “Alarm”.

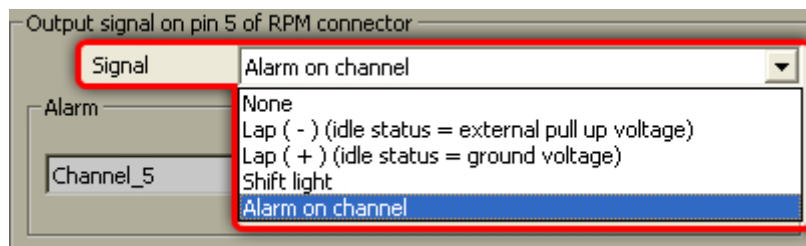

Available options are:

- **None:** signal disabled.
- **Lap (-) (idle status = external pull up voltage):** when **EVO4** receives a lap signal, the signal emitted decreases from pull-up voltage (idle status) to 0V (lap) for about 0,8 seconds.
- **Lap (+) (idle status = ground voltage):** when **EVO4** receives a lap signal, the signal emitted grows from 0V (idle status) to pull-up (lap) voltage for around 0,8 seconds.
- **Shift lights:** when RPM are over threshold value, the signal emitted grows from 0V (OFF status) to pull-up voltage (ON status) for the time period the threshold value is overcome. This function can be useful to switch on an alarm led on the display. Fill in the proper case highlighted in the figure below.

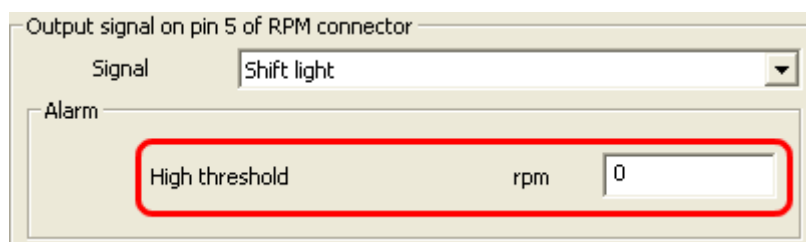

- **Alarm on channel:** starts up an alarm when a fixed threshold value is reached. With reference to the image below on the left, to enable this option select the channel where to set the alarm on (1), set it as max/min alarm clicking the central button (2) and fill in its threshold value (3). The image on the right shows the alarm set: an alarm switches on when Engine (1) RPM is higher (2) than 8000 (3).

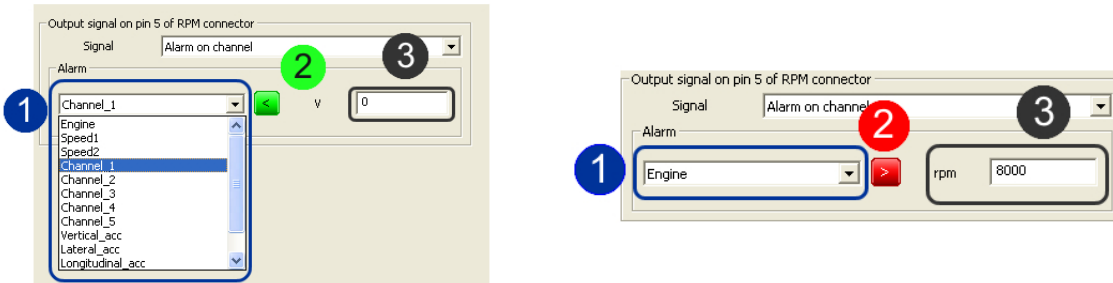

The image here below shows the connection scheme of the RPM connector digital output of **EVO4**.

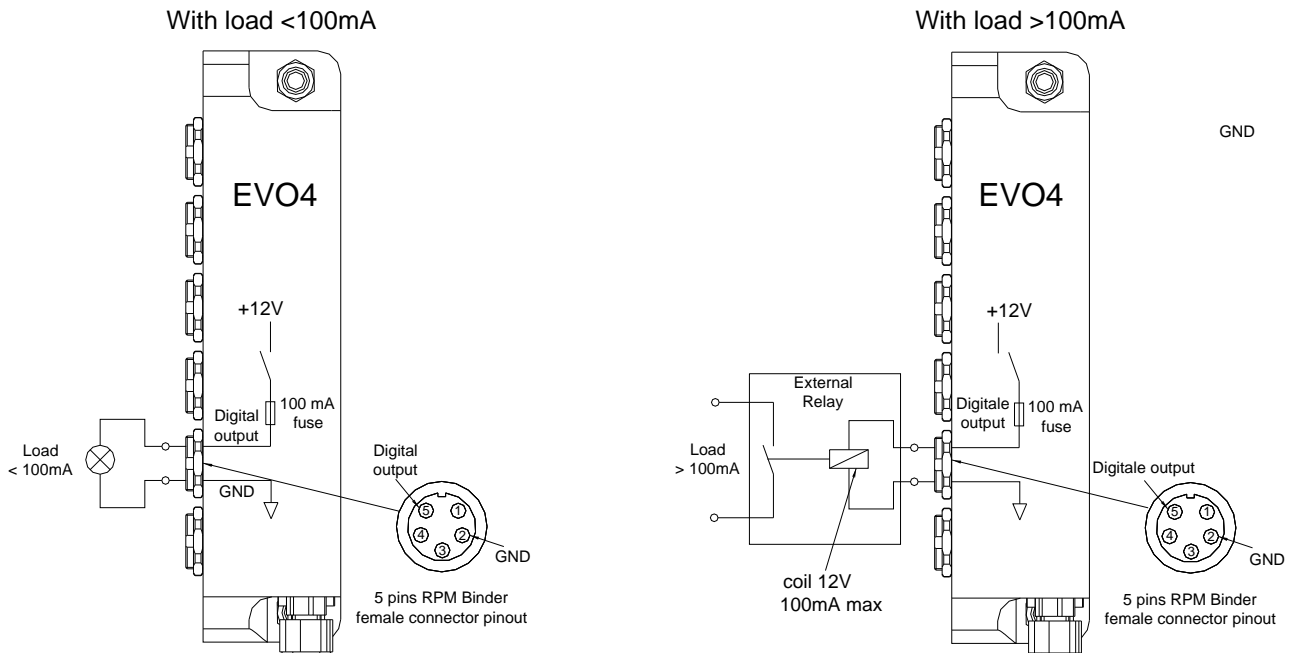

2.7 – Analog channels

EVO4 analog channels can be sampled through the connectors labelled “CH1”, “CH2”, “CH3”, “CH4” and “CH5”.

To plug any sensor in these channels extensions are required. They have to be ordered specifying the logger they have to be connected to and the sensor to be used. Extensions are available in length multiples of 50 cm (from 50 to 300 cm).

2.8 – Led status signal

The **led** placed bottom on the right of **EVO4** front has a double function. It switches on when **EVO4** is powered and shows logger status according to this scheme:

- led blinking 1Hz: **EVO4** in standby;
- led steady: **EVO4** is recording;
- led blinking 3 Hz: configuration not OK;
- led blinking with alternate colours: logger is updating firmware.

Chapter 3 – Installation and powering

Install **EVO4**, its expansions and display in a place where the devices are not in contact with heat sources or electromagnetic interference sources like spark plugs and coil.

3.1 – How to power EVO4

EVO4 needs a 8-18 VDC non stabilized power source.

It is suggested to power **EVO4** through the vehicle master switch to save vehicle battery charge.

3.1.1 – GND

For a correct powering and sensors signal stability connect cable labelled GND of **EVO4** powering wiring to the vehicle chassis earth as highlighted in the figure below.

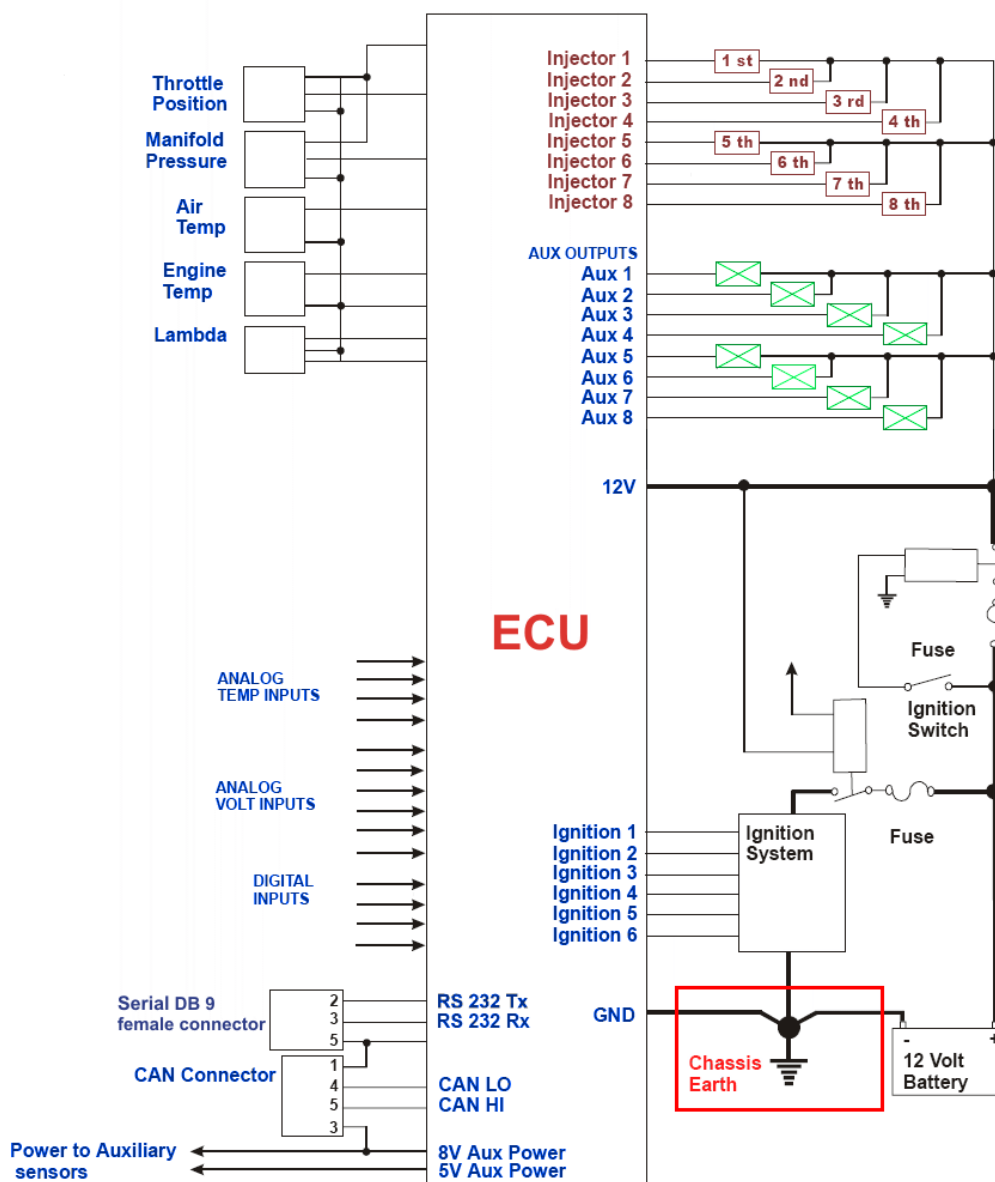

3.2 – The three-axial accelerometer.

EVO4 is equipped with an internal three-axial accelerometer that is automatically configured by the software according to the way the logger is installed on the vehicle. To set the accelerometer follow this procedure:

- activate channels layer (shown here below);

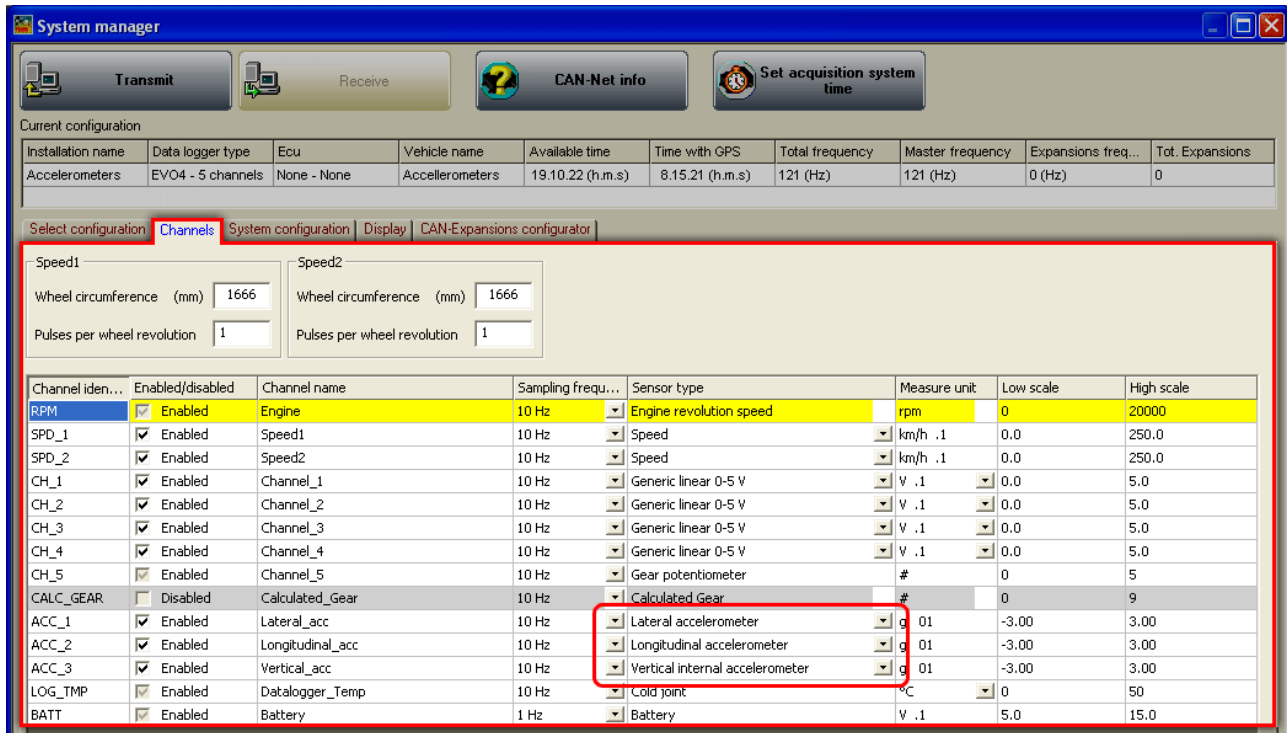

- click twice on the accelerometer to set; the panel here below appears;

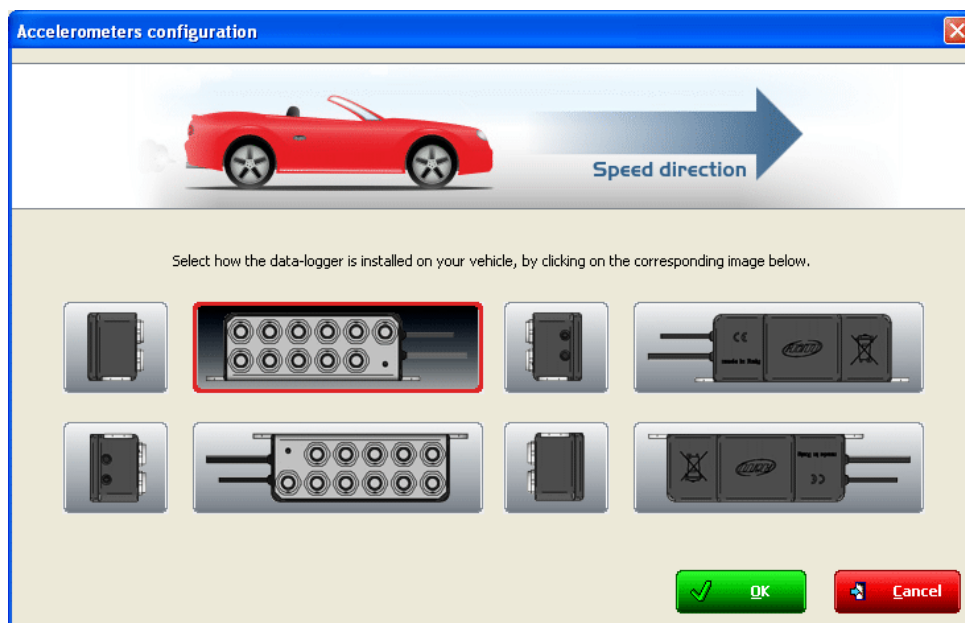

- select the position corresponding to EVO4 installation; the system highlights the selection red circling the selected button;

- the system automatically sets the three accelerometer axes as shown here below.

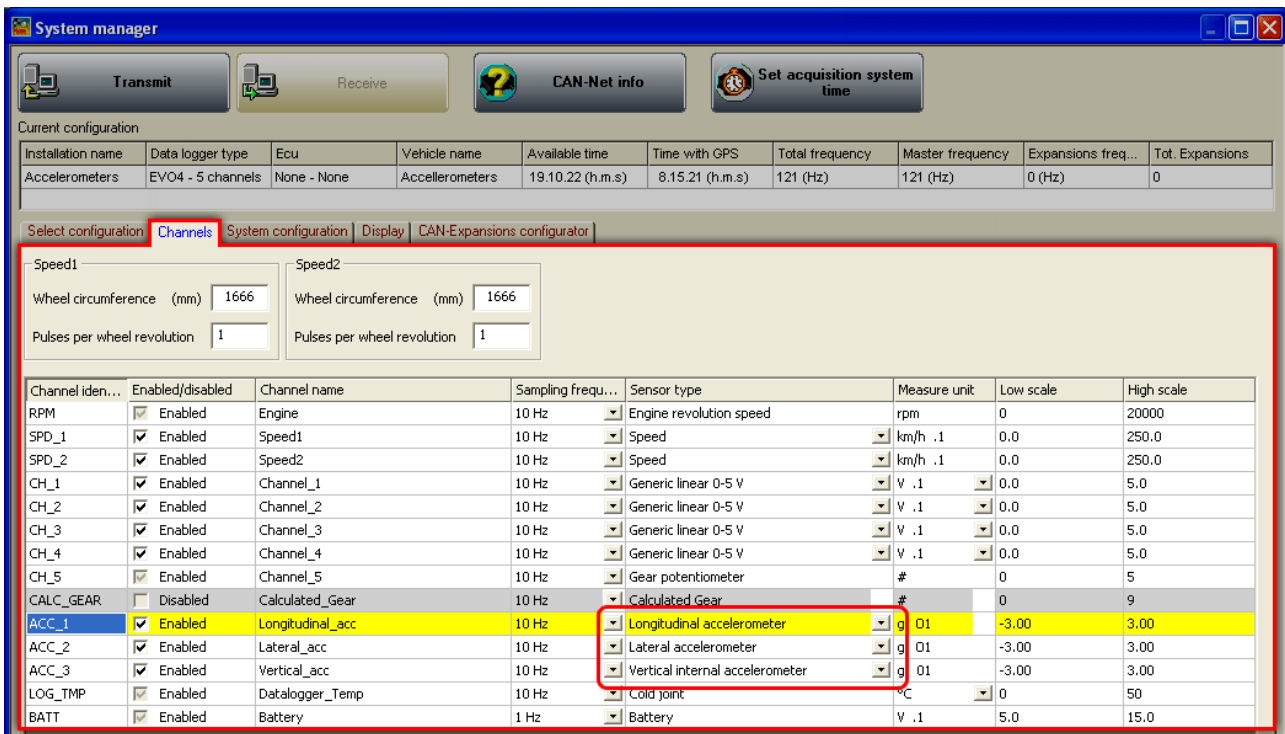

System manager

Transmit Receive CAN-Net info Set acquisition system time

Current configuration

Installation name	Data logger type	Ecu	Vehicle name	Available time	Time with GPS	Total frequency	Master frequency	Expansions freq...	Tot. Expansions
Accelerometers	EVO4 - 5 channels	None - None	Accelerometers	19.10.22 (h.m.s)	8.15.21 (h.m.s)	121 (Hz)	121 (Hz)	0 (Hz)	0

Select configuration Channels System configuration Display CAN-Expansions configurator

Speed1 Speed2

Wheel circumference (mm) 1666 Wheel circumference (mm) 1666

Pulses per wheel revolution 1 Pulses per wheel revolution 1

Channel iden...	Enabled/disabled	Channel name	Sampling frequ...	Sensor type	Measure unit	Low scale	High scale
RPM	<input checked="" type="checkbox"/> Enabled	Engine	10 Hz	Engine revolution speed	rpm	0	20000
SPD_1	<input checked="" type="checkbox"/> Enabled	Speed1	10 Hz	Speed	km/h .1	0.0	250.0
SPD_2	<input checked="" type="checkbox"/> Enabled	Speed2	10 Hz	Speed	km/h .1	0.0	250.0
CH_1	<input checked="" type="checkbox"/> Enabled	Channel_1	10 Hz	Generic linear 0-5 V	V .1	0.0	5.0
CH_2	<input checked="" type="checkbox"/> Enabled	Channel_2	10 Hz	Generic linear 0-5 V	V .1	0.0	5.0
CH_3	<input checked="" type="checkbox"/> Enabled	Channel_3	10 Hz	Generic linear 0-5 V	V .1	0.0	5.0
CH_4	<input checked="" type="checkbox"/> Enabled	Channel_4	10 Hz	Generic linear 0-5 V	V .1	0.0	5.0
CH_5	<input checked="" type="checkbox"/> Enabled	Channel_5	10 Hz	Gear potentiometer	#	0	5
CALC_GEAR	<input type="checkbox"/> Disabled	Calculated_Gear	10 Hz	Calculated Gear	#	0	9
ACC_1	<input checked="" type="checkbox"/> Enabled	Longitudinal_acc	10 Hz	Longitudinal accelerometer	g .01	-3.00	3.00
ACC_2	<input checked="" type="checkbox"/> Enabled	Lateral_acc	10 Hz	Lateral accelerometer	g .01	-3.00	3.00
ACC_3	<input checked="" type="checkbox"/> Enabled	Vertical_acc	10 Hz	Vertical internal accelerometer	g .01	-3.00	3.00
LOG_TMP	<input checked="" type="checkbox"/> Enabled	Datalogger_Temp	10 Hz	Cold joint	°C	0	50
BATT	<input checked="" type="checkbox"/> Enabled	Battery	1 Hz	Battery	V .1	5.0	15.0

Once the channel is set it is possible to verify if it corresponds to the logger position double clicking on the channel itself. The panel before appears showing the position corresponding to that setting.

Refer to Race Studio Configuration user manual, freely downloadable from the website www.aim-sportline.com, download area software section for further information concerning channels setting.

3.3 – Installing and powering the IR transmitter and receiver

AIM provides a range of beacon equipments:

3.3.1 – The infrared (IR) transmitter

The image here below shows AIM IR lap transmitter:



The transmitter can be internally or externally powered:

- internally: with 8 AA batteries (placed in the transmitter case); when battery charge status is low power led starts blinking each second (1Hz);
- externally: with an external 12 V power cable; when battery charge status is low the led starts blinking each second.

The transmitter has 2 working modes:

- Low power mode: for tracks whose width is less than 10 m (30 ft);
- High power mode: for tracks whose width is more than 10 m (30 ft); in this second case external 12V power is necessary and both led switch on when the transmitter is switched on.

To activate High/Low power mode it is necessary to unscrew the back of the transmitter case as shown here below on the left;

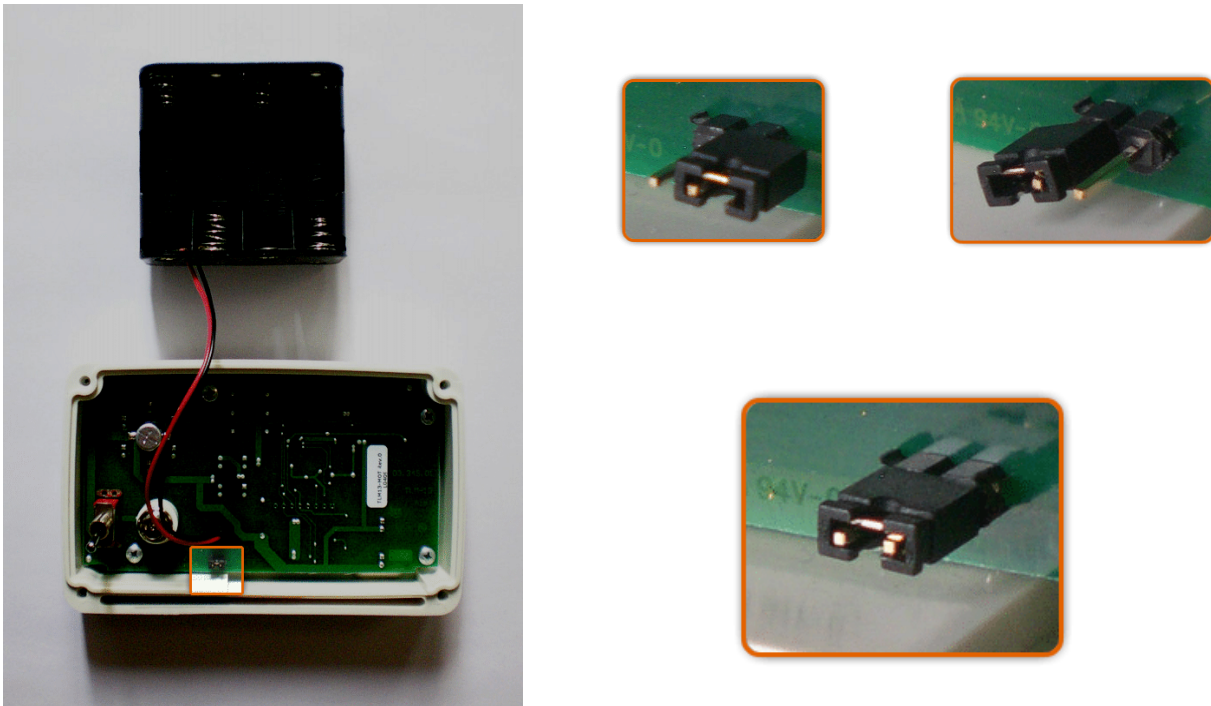

The image here above on the right shows possible working mode. The transmitter comes set in low power mode: see images top on the right. To set high power mode insert both clips in the jumper: image bottom on the right.

Warning: it is recommended to verify the number of transmitters already installed on the circuit before installing your own. It is in fact possible that there are transmitters additional to the one placed on the start/finish line. The simplest way to record correct times is using the same transmitter(s) for all racers.

3.3.2 – The infrared (IR) receiver

The infrared receiver has to be installed on the vehicle so that it can see the transmitter placed on the side of the track. The red circle in the figure below indicates the receiver eye.



3.4 – How to install EVO4 displays

EVO4 can be connected to an AIM display to see channels and alarms during the race. The available displays are **MyChron3 Dash**, **TG Dash**, **Formula Steering Wheel**.

Information shown in the different display pages can be configured by the user through **Race Studio 2** software.

Please refer to each display user manual for further information concerning their working mode and to Race Studio Configuration user manual for the display configuration. The manual are downloadable from www.aim-sportline.com download area documentation section (displays user manual) and software section (Race Studio Configuration user manual).

3.5 – GPS lap timer through the displays

EVO4 can use the connected display to show lap/split times using GPS lap timer without using any external lap/split transmitter.

3.5.1 – GPS lap timer configuration

For **EVO4** to compute lap times using GPS lap timer it is necessary to set this option in its configuration and then transmit it to the logger. Refer to Race Studio Configuration user manual – chapter “**EVO4**” and “Transmitting the configuration” – for further information.

3.5.2 – How to configure GPS lap timer on the display.

To set lap and splits on the display via keyboard refer to each display user manual.

Chapter 4 – EVO4 memory

EVO4 is equipped with an internal flash memory whose characteristics are:

- **16 Mb**;
- **non volatile** (data are stored also when the logger is off);
- **round** (when it is full, new data automatically overwrite the old ones).

Memory roundness implies an automatic over-writing of old data. To avoid losing data it is suggested to set each channel sampling frequency on a value that guarantees a sufficient amount of time.

Channels sampling frequency is set using **Race Studio 2** software. In the image here below – showing channel layer – the case 'Available time' is highlighted. It shows the time available with the sampling frequency currently set on each channel.

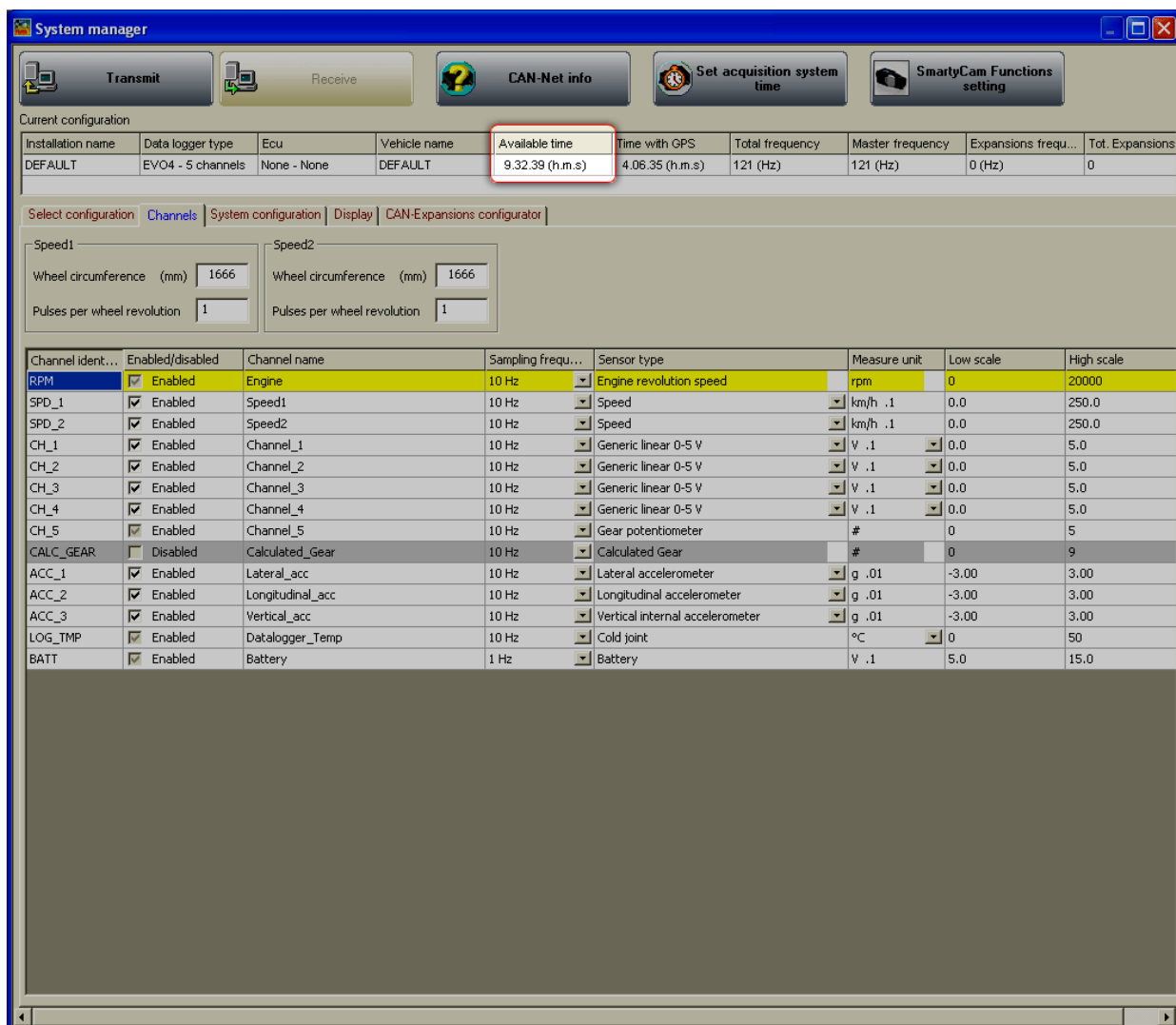

The screenshot shows the 'System manager' window with the 'Channels' tab selected. The 'Current configuration' table is as follows:

Installation name	Data logger type	Ecu	Vehicle name	Available time	Time with GPS	Total frequency	Master frequency	Expansions frequ...	Tot. Expansions
DEFAULT	EVO4 - 5 channels	None - None	DEFAULT	9.32.39 (h.m.s)	4.06.35 (h.m.s)	121 (Hz)	121 (Hz)	0 (Hz)	0

The 'Channels' table below shows the following data:

Channel ident...	Enabled/disabled	Channel name	Sampling frequ...	Sensor type	Measure unit	Low scale	High scale
RPM	Enabled	Engine	10 Hz	Engine revolution speed	rpm	0	20000
SPD_1	Enabled	Speed1	10 Hz	Speed	km/h .1	0.0	250.0
SPD_2	Enabled	Speed2	10 Hz	Speed	km/h .1	0.0	250.0
CH_1	Enabled	Channel_1	10 Hz	Generic linear 0-5 V	V .1	0.0	5.0
CH_2	Enabled	Channel_2	10 Hz	Generic linear 0-5 V	V .1	0.0	5.0
CH_3	Enabled	Channel_3	10 Hz	Generic linear 0-5 V	V .1	0.0	5.0
CH_4	Enabled	Channel_4	10 Hz	Generic linear 0-5 V	V .1	0.0	5.0
CH_5	Enabled	Channel_5	10 Hz	Gear potentiometer	#	0	5
CALC_GEAR	Disabled	Calculated_Gear	10 Hz	Calculated Gear	#	0	9
ACC_1	Enabled	Lateral_acc	10 Hz	Lateral accelerometer	g .01	-3.00	3.00
ACC_2	Enabled	Longitudinal_acc	10 Hz	Longitudinal accelerometer	g .01	-3.00	3.00
ACC_3	Enabled	Vertical_acc	10 Hz	Vertical internal accelerometer	g .01	-3.00	3.00
LOG_TMP	Enabled	Datalogger_Temp	10 Hz	Cold joint	°C	0	50
BATT	Enabled	Battery	1 Hz	Battery	V .1	5.0	15.0

Modifying each channel sampling frequency available time can increase or decrease. Refer to **Race Studio Configuration** user manual for further information concerning channels setting and their sampling frequency.

Chapter 5 – EVO4: software, driver, configuration, transmission, data download, online function, maintenance

EVO4 connects easily to a PC through the USB cable and can be configured only through **Race Studio 2**.

EVO4 standard kit includes the USB cable and **Race Studio 2** and USB driver installation CD.

Warning: the logger can be configured only after software and driver installation. Periodically check on www.aim-sportline.com new releases of Race Studio 2 software and/or EVO4 firmware.

Race Studio Configuration user manual, downloadable from download area, software section of AIM corporate website www.aim-sportline.com, includes all information about:

- how to install **Race Studio 2** under Microsoft Windows XP®, Microsoft Windows Vista® (32 bit only);
- how to configure **EVO4** and set its channels;
- how to configure **EVO4** CAN expansions and set their channels;
- how to configure **EVO4** display and set its channels;
- setting and managing standard and custom sensors;
- calibrating and auto-calibrating sensors;
- transmitting the configuration to **EVO4** once set;
- gear calculation;
- data download;
- online function.



EVO4 needs no special maintenance. Just take care of the logger and its components; the only suggested maintenance is a periodic software/firmware updating:

Updates are constantly released by AIM and issued on www.aim-sportline.com, download area firmware/software section.

To update firmware/software it is necessary to:

- connect to www.aim-sportline.com;
- click on “Download area”;
- click on the corresponding section depending on what is to be updated: software or firmware;
- select the software/firmware to be updated;
- check if any update has been released;
- download and run them double clicking on the file;
- follow the instructions that appear on the PC monitor.

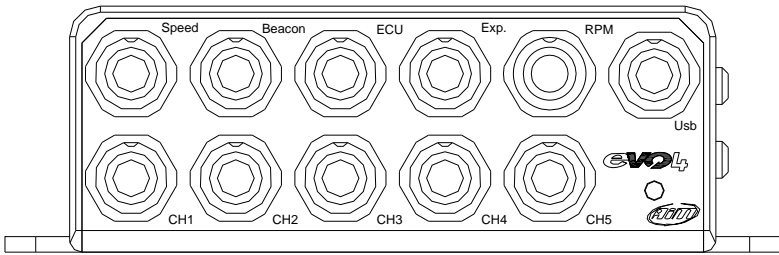
Appendix – Technical drawings

N.rev. / Rev. N.		Descrizione / Description			Data / date	Firma / Sign	Contr. da / Ckd. by										
<h3>PINOUT EVO4</h3> 																	
4 Pins Female Binder connector labelled SPEED		4 Pins Female Binder connector labelled BEACON		5 Pins Female Binder connector labelled ECU		5 Pins Female Binder connector labelled EXP		5 Pins Female Binder connector labelled RPM									
1	SPEED1	1	Magnetic Lap	1	RS232TX	1	CAN 0+	1	RPM 150-450								
2	GND	2	GND	2	GND	2	GND	2	GND								
3	+VB	3	+VB	3	CAN 1+	3	+VB	3	RPM 4-50 V								
4	SPEED2	4	Optical Lap	4	RS232RX	4	CAN 0-	4	K Line								
				5	CAN 1-	5	VB Ext.	5	Digital Output								
<table border="1" style="width: 100%; border-collapse: collapse;"> <thead> <tr> <th colspan="2">3 Pins Female Binder connector labelled USB</th> </tr> </thead> <tbody> <tr> <td>1</td><td>USB D+</td> </tr> <tr> <td>2</td><td>USB D-</td> </tr> <tr> <td>3</td><td>GND</td> </tr> </tbody> </table>										3 Pins Female Binder connector labelled USB		1	USB D+	2	USB D-	3	GND
3 Pins Female Binder connector labelled USB																	
1	USB D+																
2	USB D-																
3	GND																
4 Pins Female Binder connector labelled CH1		4 Pins Female Binder connector labelled CH2		4 Pins Female Binder connector labelled CH3		4 Pins Female Binder connector labelled CH4		4 Pins Female Binder connector labelled CH5									
1	Analog Input 1	1	Analog Input 2	1	Analog Input 3	1	Analog Input 4	1	Analog Input 5								
2	GND	2	GND	2	GND	2	GND	2	GND								
3	+VB	3	+VB	3	+VB	3	+VB	3	+VB								
4	V Ref	4	V Ref	4	V Ref	4	V Ref	4	V Ref								
Rif. / Ref.	Q.tà / Q.ty	Materiale / Material			N. articolo / Item N.												
Progettato da / Designed by L.I.		Contr. da / Ckd. by		Approvato da / Approved by		Nome file / File name		Data / Date 16/12/10	Scala / Scale								
				Titolo / Title Pinout EVO4													
				N. disegno / Drawing N.			Rev. / Rev.		Foglio / Sheet 1 of 1								

N.rev. / Rev. N.	Descrizione / Description	Data / date	Firma / Sign	Contr. da / Ckd. by
------------------	---------------------------	-------------	--------------	---------------------

USB cable for EVO4

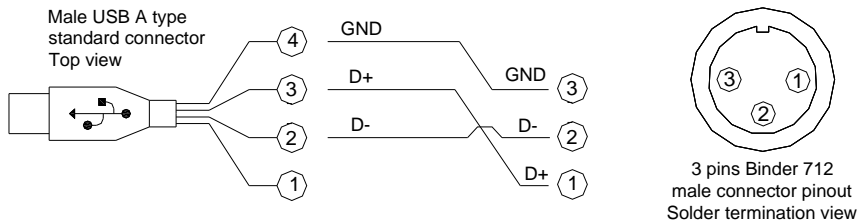
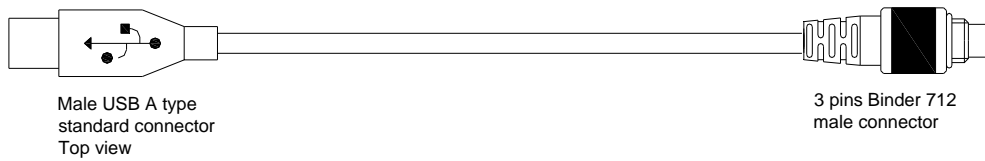

USB male connector pinout
Frontal view

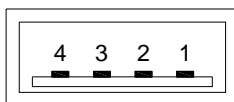

Rif. / Ref.	Q.tà / Q.ty	Materiale / Material	N. articolo / Item N.		
Progettato da / Designed by D.B.	Contr. da / Ckd. by	Approvato da / Approved by	Nome file / File name	Data / Date	Scala / Scale
 Racing Data Power		Titolo / Title USB cable for EVO4			
		N. disegno / Drawing N. 04.563.03	Rev. / Rev.	Foglio / Sheet 1 of 1	

N.rev. / Rev. N.	Descrizione / Description	Data / date	Firma / Sign	Contr. da / Ckd. by
------------------	---------------------------	-------------	--------------	---------------------

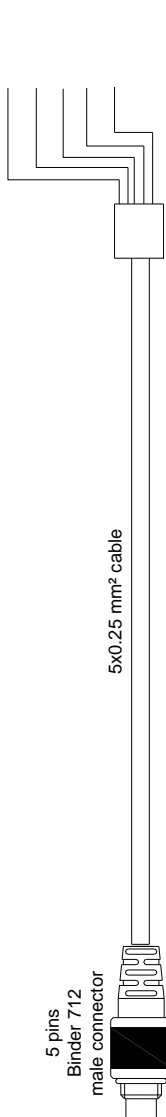

RPM, gear flash and K line cable for EVO4

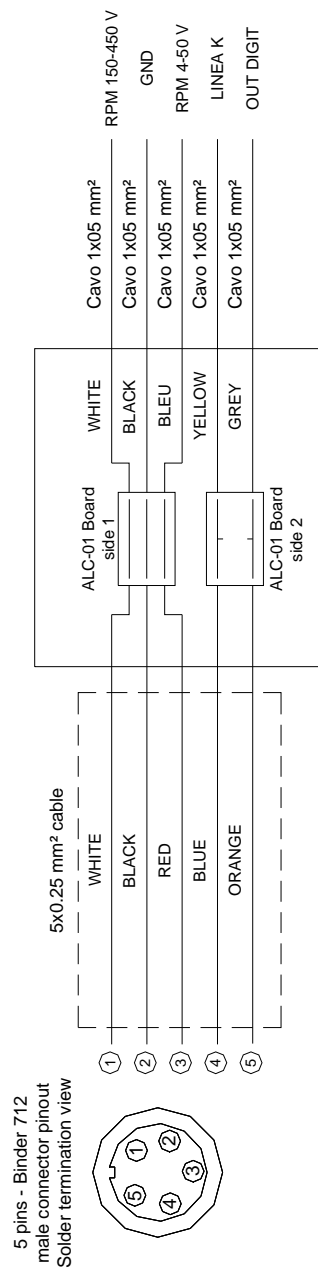

Connections

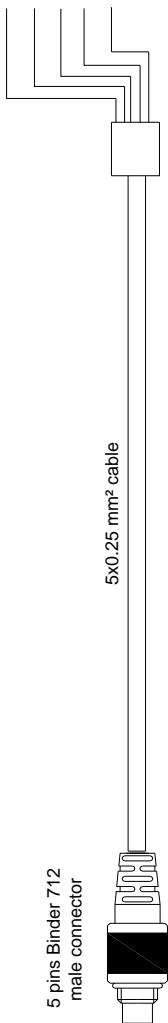
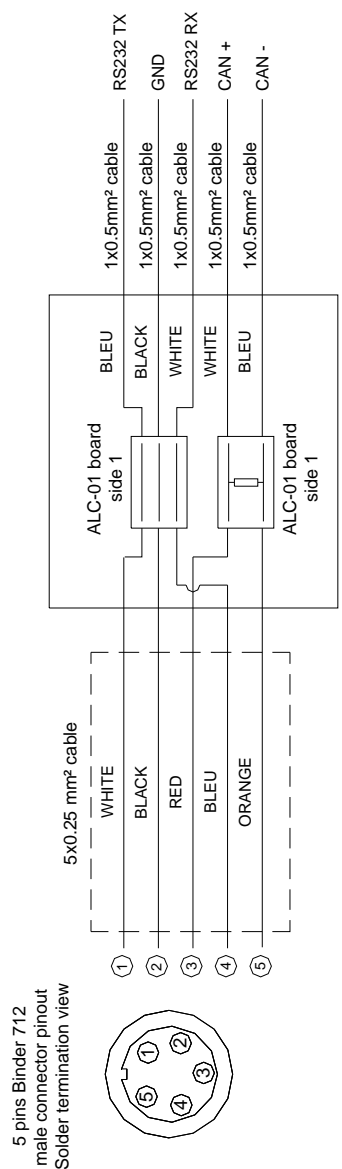

Rif. / Ref.	Q.tà / Q.ty	Materiale / Material	N. articolo / Item N.	
Progettato da / Designed by D.B.	Contr. da / Ckd. by	Approvato da / Approved by	Nome file / File name	Data / Date
		Titolo / Title Cavo RPM, gear flash e linea K per EVO4		
		N. disegno / Drawing N. 04.563.02	Rev. / Rev. 1	Foglio / Sheet 1 of 1

N.rev. / Rev. N.		Descrizione / Description		Data / date	Firma / Sign	Contr. da / Ckd. by
<h1>EVO4 CAN and serial ECU connection cable</h1>						
						
<h2>Connections</h2>						
						
Rif. / Ref.	Q.tà / Q.ty	Materiale / Material		N. articolo / Item N.		
Progettato da / Designed by D.B.	Contr. da / Ckd. by	Approvato da / Approved by	Nome file / File name	Data / Date	Scala / Scale	
		Titolo / Title Cavo seriale e CAN per connessione ECU EVO4				
		N. disegno / Drawing N.	04.563.01	Rev. / Rev.	Foglio / Sheet	
Racing Data Power				1	1 of 1	

N.rev. / Rev. N.	Descrizione / Description	Data / date	Firma / Sign	Contr. da / Ckd. by
------------------	---------------------------	-------------	--------------	---------------------

EVO4 K and L line cable with OBDII connection

5 pins Binder 7-12
male connector



2x0.35 mm² cable

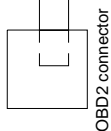

OBD2 connector

Connection

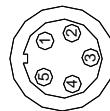



5 pins Binder 7-12
male connector pinout
solder termination view

red K Line

black GND

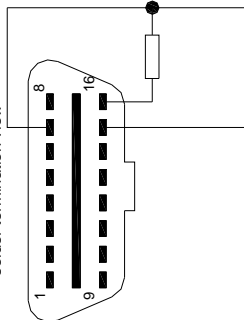
not cabled 16 pins "OBD2"
connector pinout
solder termination view



Rif. / Ref.	Q.tà / Q.ty	Materiale / Material	N. articolo / Item N.		
Progettato da / Designed by D.B.	Contr. da / Ckd. by	Approvato da / Approved by	Nome file / File name	Data / Date	Scala / Scale
 Racing Data Power		Titolo / Title Cavo linea K ed L con connessione OBDII per EVO4			
		N. disegno / Drawing N. 04.563.05	Rev. / Rev.	Foglio / Sheet 1 of 1	

N.rev. / Rev. N.	Descrizione / Description	Data / date	Firma / Sign	Contr. da / Ckd. by
------------------	---------------------------	-------------	--------------	---------------------

EVO4 CAN cable with OBDII connection



Connections

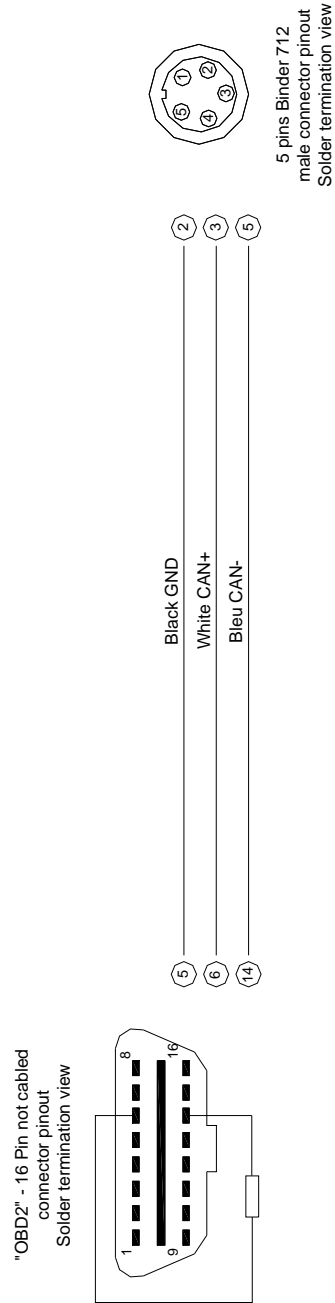

Rif. / Ref.	Q.tà / Q.ty	Materiale / Material	N. articolo / Item N.	
Progettato da / Designed by D.B.	Contr. da / Ckd. by	Approvato da / Approved by	Nome file / File name	Data / Date
		Titolo / Title Cavo CAN con connessione OBDII per EVO4		
N. disegno / Drawing N. 04.563.04		Rev. / Rev.	Foglio / Sheet 1 of 1	